

Hope Valley Blacksmith

FREE MINIATURE PAPER MODEL <https://hopevalleyprintables.wordpress.com>

PRINT IN ORDINARY PAPER,
FOLD ON ALL DOTTED LINES,
USE GLUE STICK

A

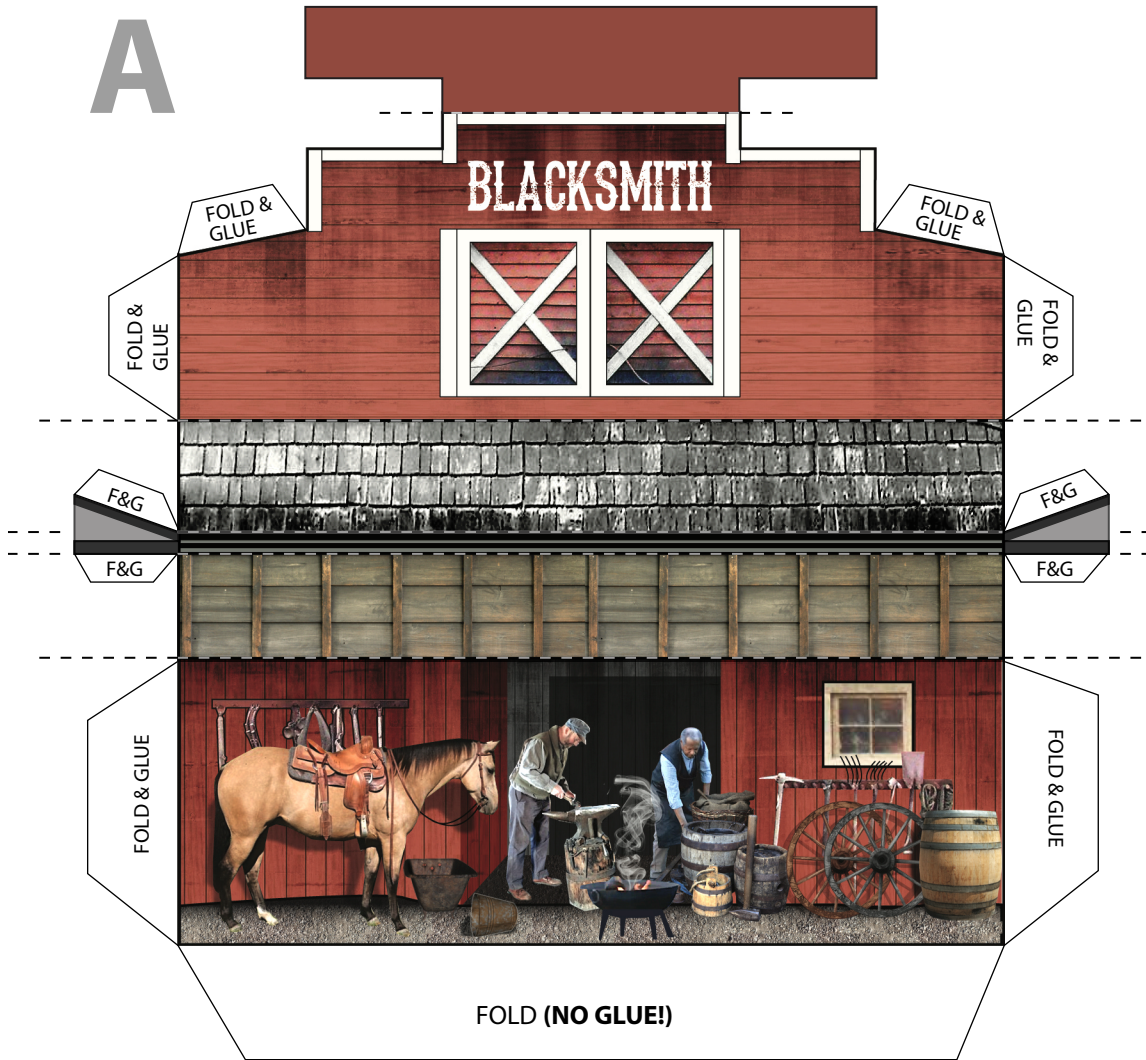

B₁

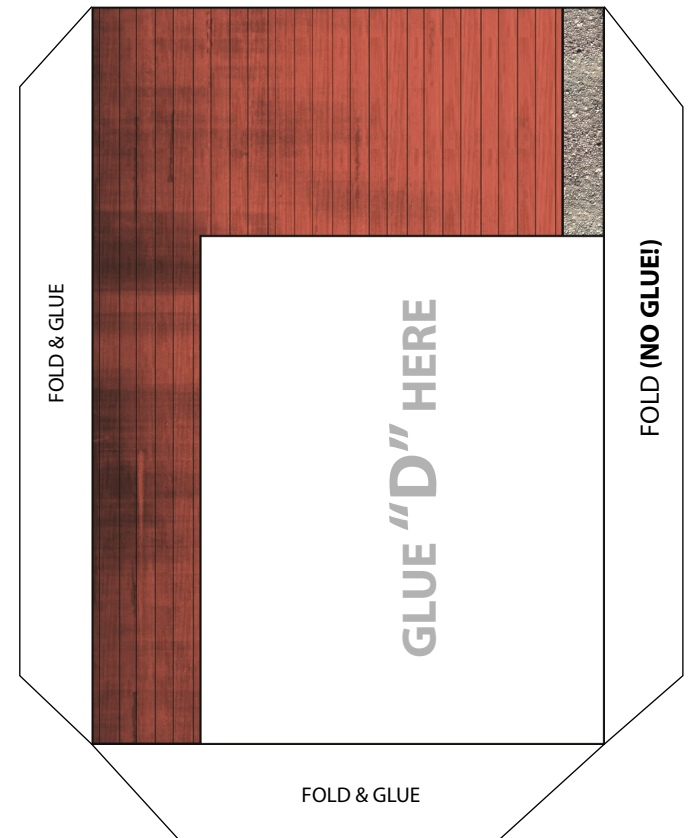

B₂

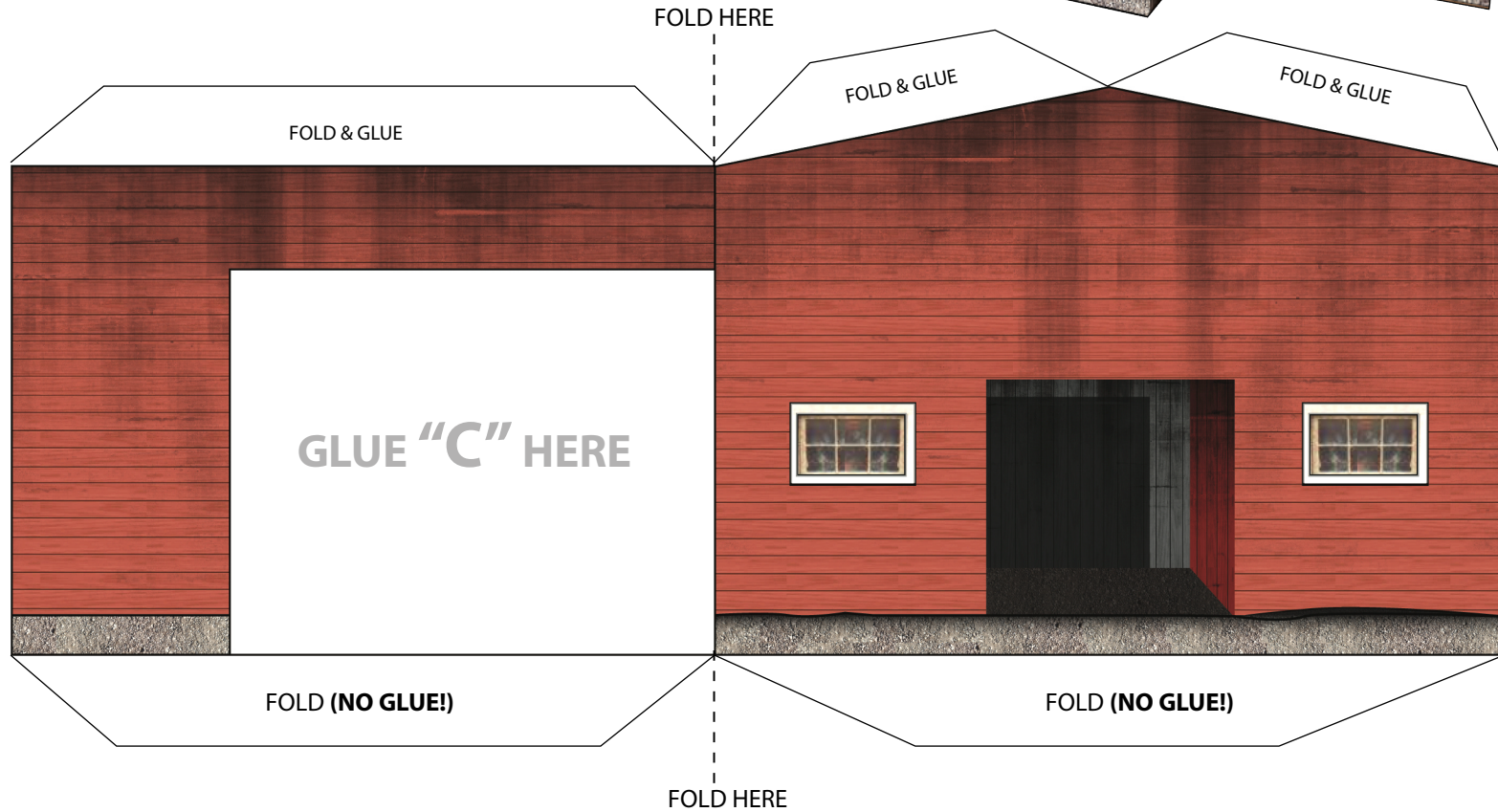
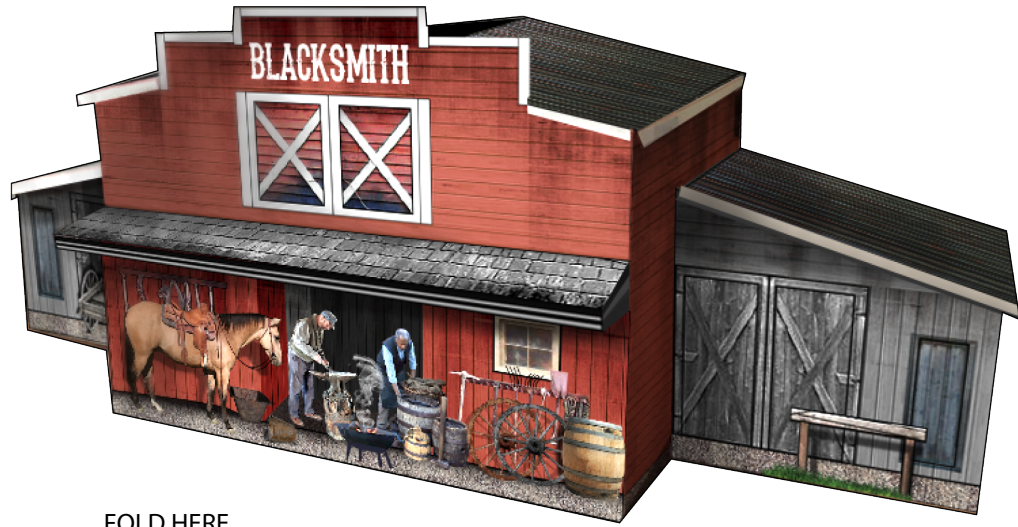

C

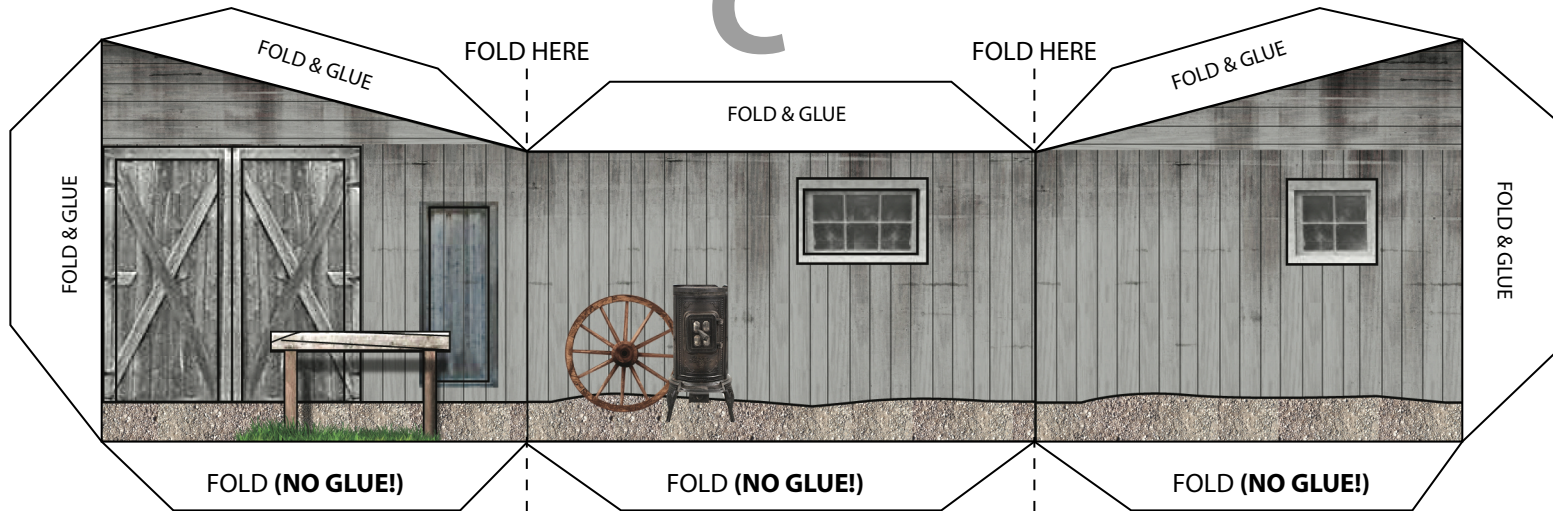

D

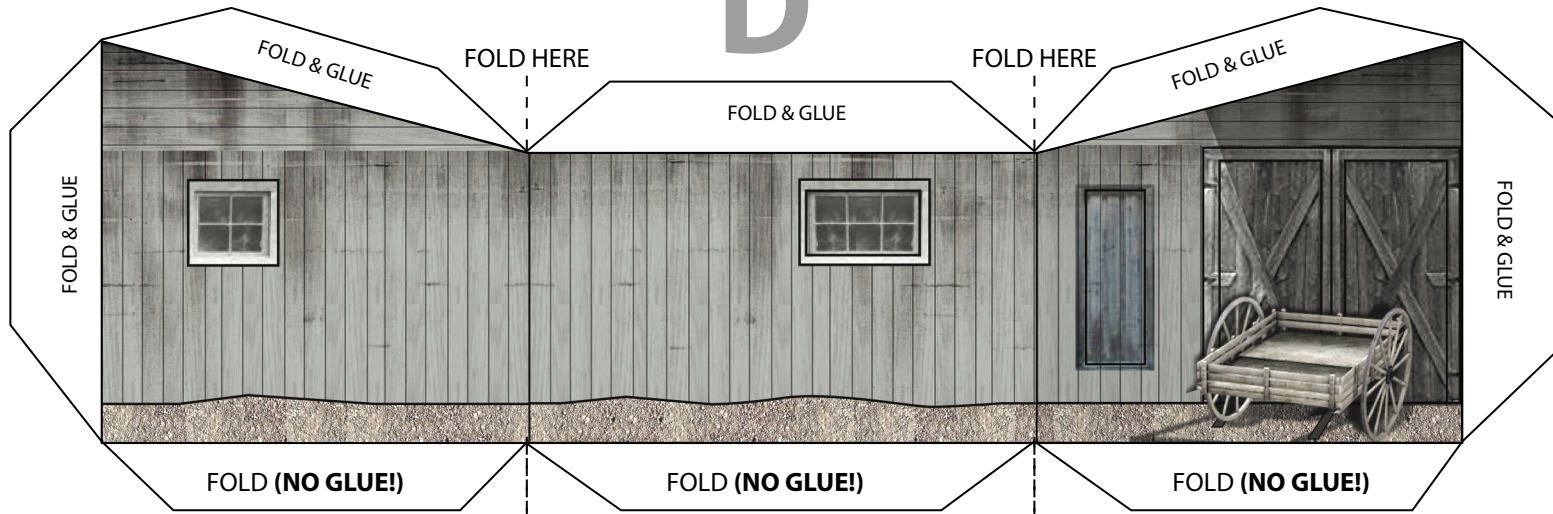

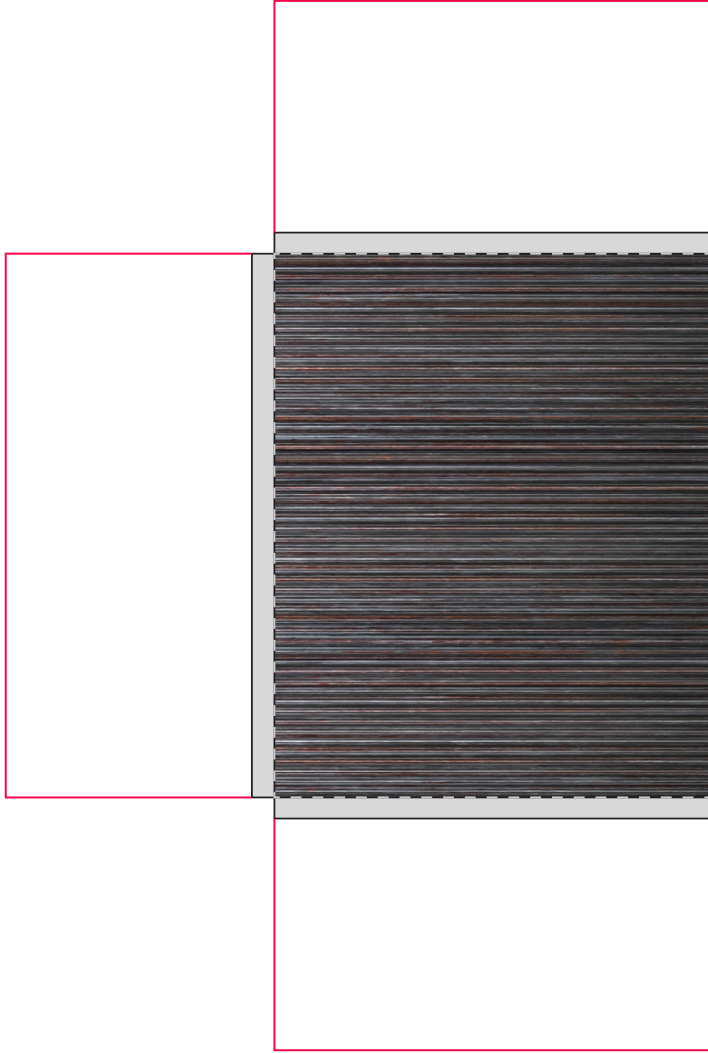

ROOF 1

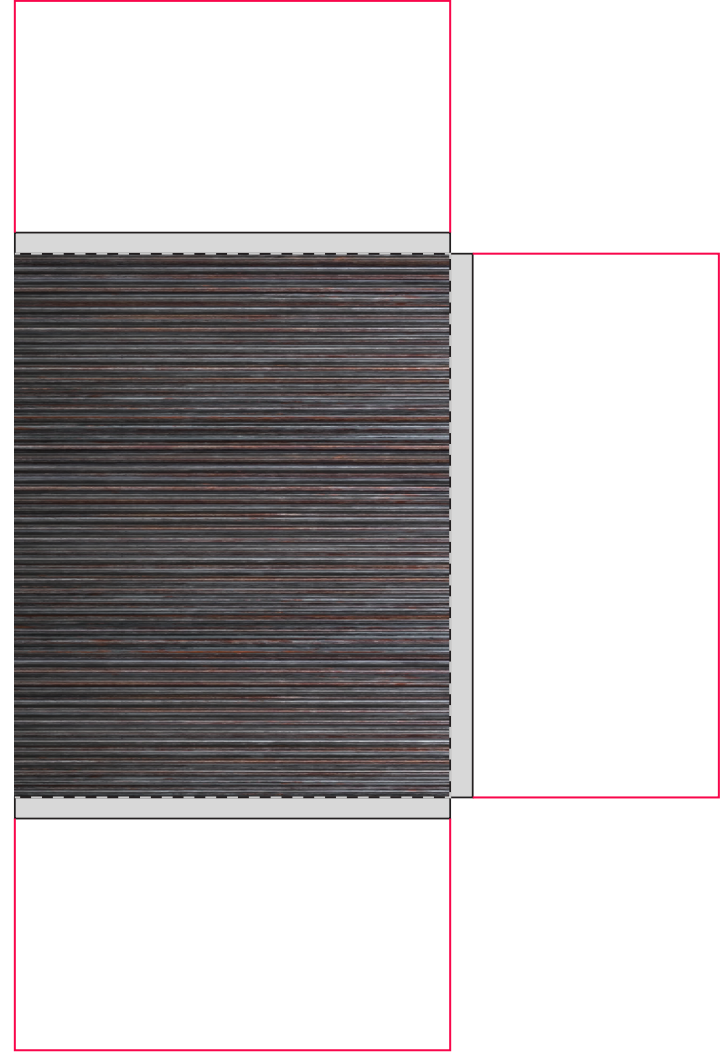

ROOF 2

ROOF 3

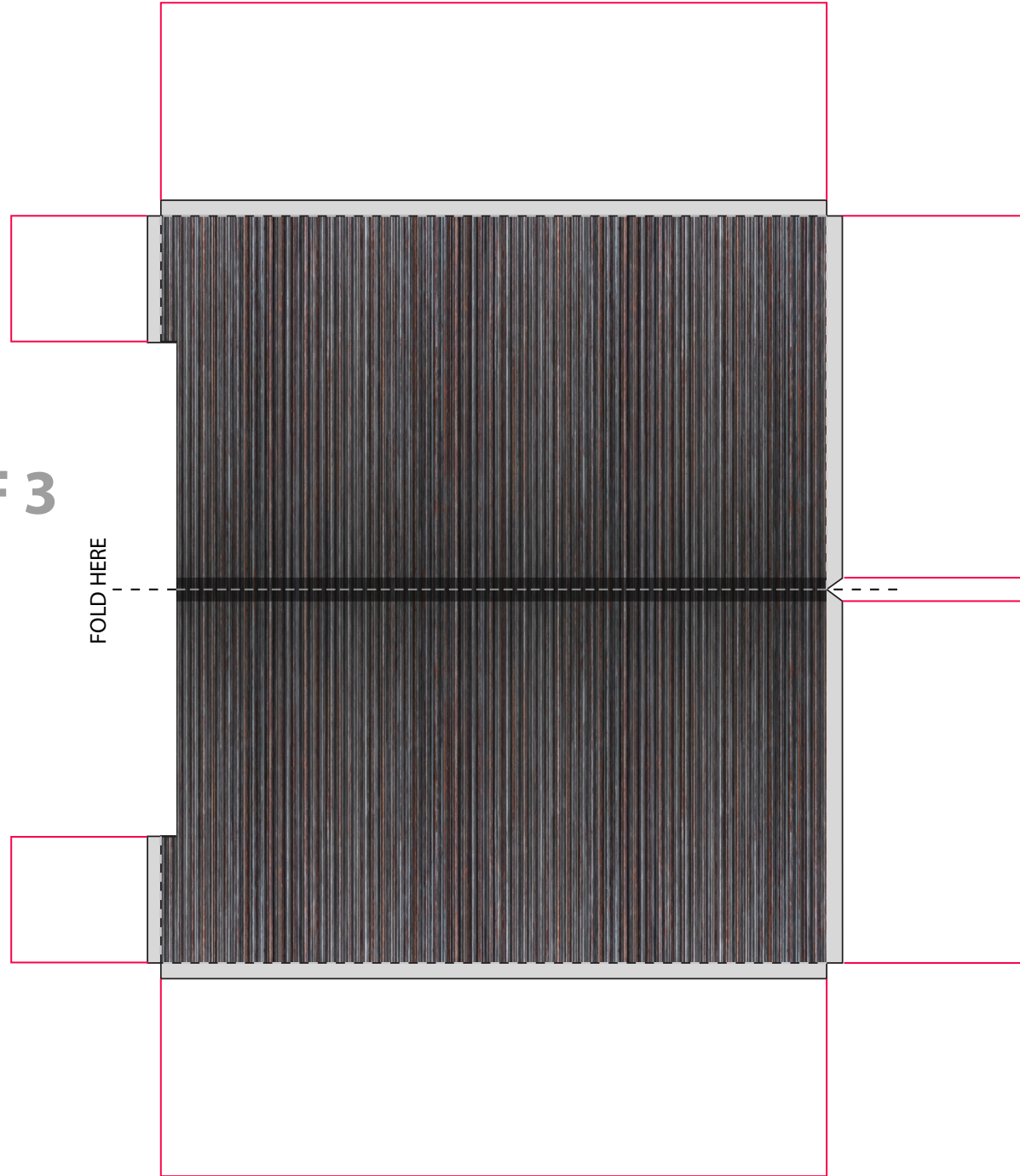

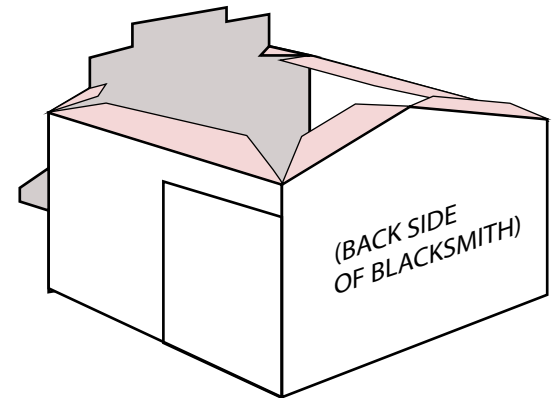
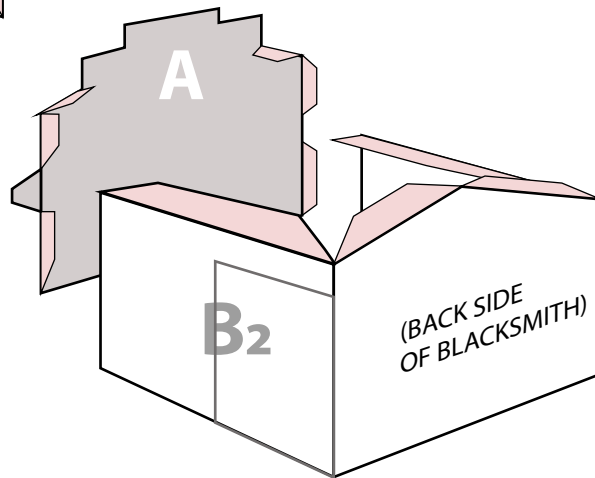
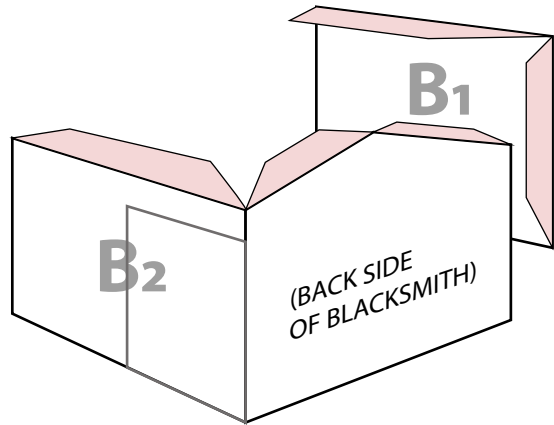
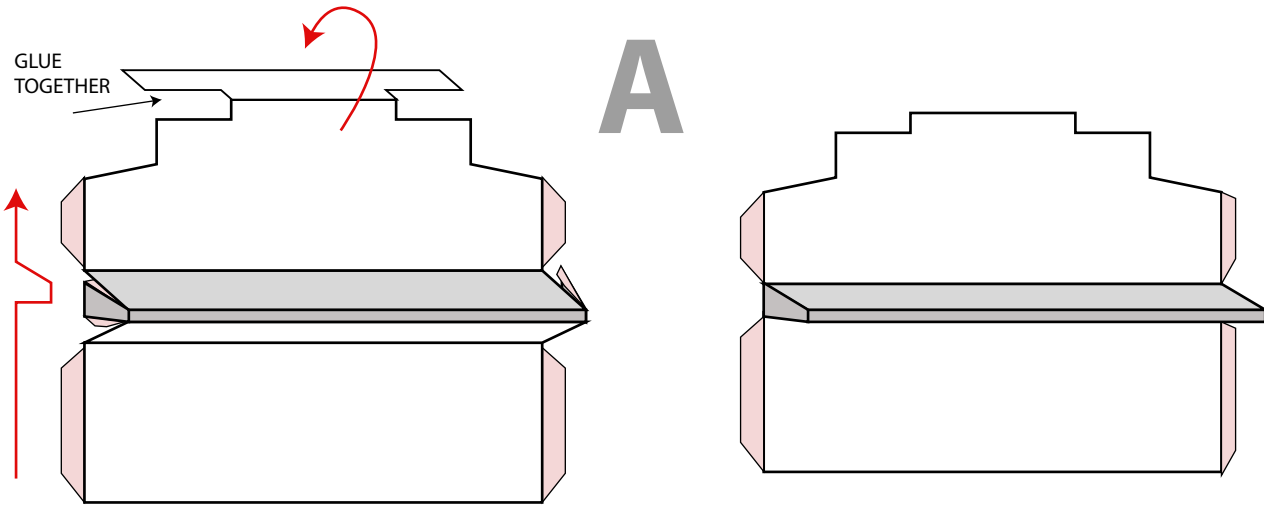

C & D

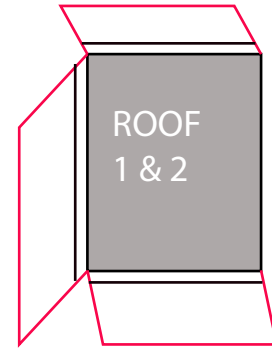
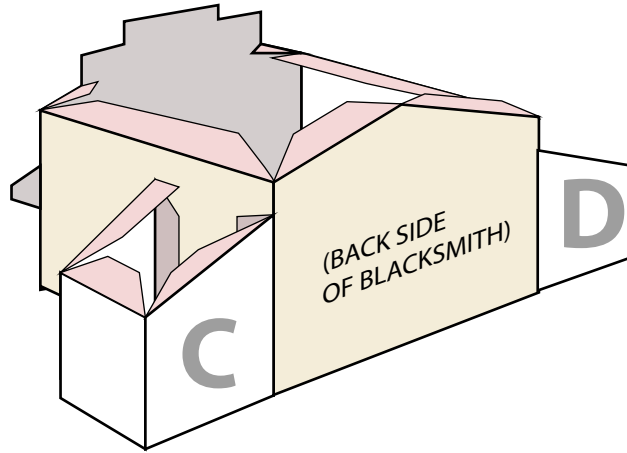
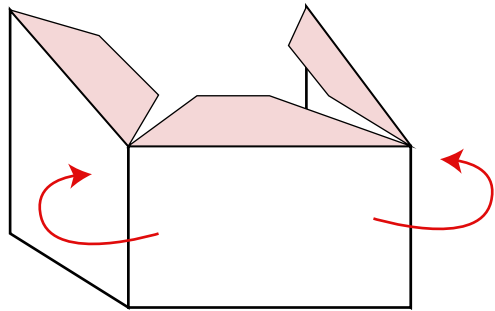

FOLD
AROUND
THE RED
LINES

CUT EXCESS
OF PAPER
LEAVING ONLY
THE FOLDED
BORDERS

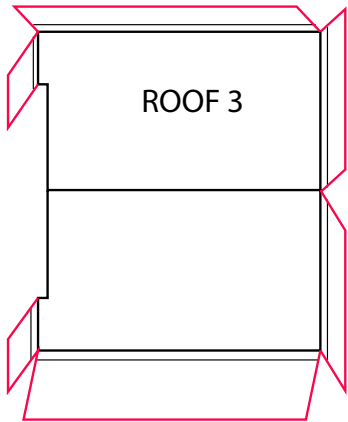

FOLD
AROUND
THE RED
LINES

CUT EXCESS
OF PAPER
LEAVING ONLY
THE FOLDED
BORDERS

